

## PESC10120

### 10.0AMPS.SIC SCHOTTKY BARRIER DIODE

#### FEATURE

- . 1200V Schottky Diode
- . Zero Reverse Recovery/Zero Forward Recovery
- . High Efficiency Operation
- . Extremely Fast Switching
- . Temperature Independent Switching Behavior

#### TYPICAL APPLICATIONS

- . Switch mode power supply
- . Power factor correction Solar Invertor
- . Solar inverter
- . Uninterruptible power supply

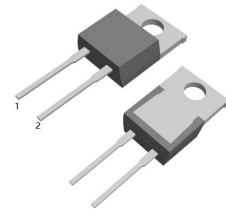

TO-220AD-2L



#### MAXIMUM RATINGS (T<sub>C</sub>=25°C unless otherwise noted)

Parameter	Symbol	PESC10120	Units
Maximum Recurrent Peak Reverse Voltage	$V_{RRM}$	1200	V
Maximum DC blocking Voltage	$V_{DC}$	1200	V
Maximum Average Forward Rectified Current at T <sub>C</sub> =150°C	$I_{F(AV)}$	10	A
Non-Repetitive Peak Forward Surge Current T <sub>c</sub> =25°C, t <sub>p</sub> =8.3 ms, Half Sine Pulse	$I_{FSM}$	95	A
Total power dissipation T <sub>c</sub> =25°C	$P_D$	136	W
Operation Junction Temperature and Storage Temperature	$T_J, T_{STG}$	-55 to +175	°C

#### ELECTRICAL CHARACTERISTICS (T<sub>C</sub>=25°C unless otherwise noted)

Parameter	Symbol	Typ	Max	Units	
Forward voltage	$V_F$	I <sub>F</sub> =10A, T <sub>j</sub> =25°C	1.45	1.8	V
		I <sub>F</sub> =10A, T <sub>j</sub> =175°C	2.0	2.3	
Reverse current	$I_R$	V <sub>R</sub> =1200V, T <sub>j</sub> =25°C	8	100	μA
		V <sub>R</sub> =1200V, T <sub>j</sub> =175°C	40	500	
Total capacitive charge	$Q_c$	41	---	nC	
Total capacitance	$C$	V <sub>R</sub> =0.1V, T <sub>j</sub> =25°C, f=1MHZ	700	---	pF
		V <sub>R</sub> =400V, T <sub>j</sub> =25°C, f=1MHZ	49	---	
		V <sub>R</sub> =800V, T <sub>j</sub> =25°C, f=1MHZ	41	---	

#### THERMAL CHARACTERISTICS(T<sub>C</sub>=25°C unless otherwise noted)

Parameter	Symbol	Typ	Max	Units
Typical Thermal Resistance Junction to Case	$R_{(JC)}$	1.1	----	°C/W

**RATING AND CHARACTERISTIC CURVES**

FIG.1-FORWARD CHARACTERISTICS

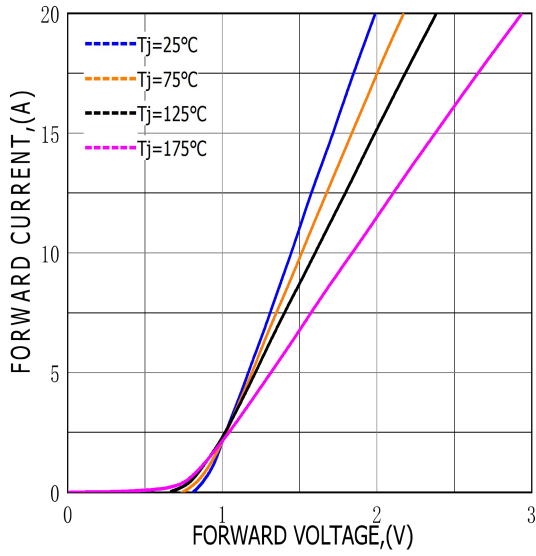

FIG.2-REVERSE CHARACTERISTICS

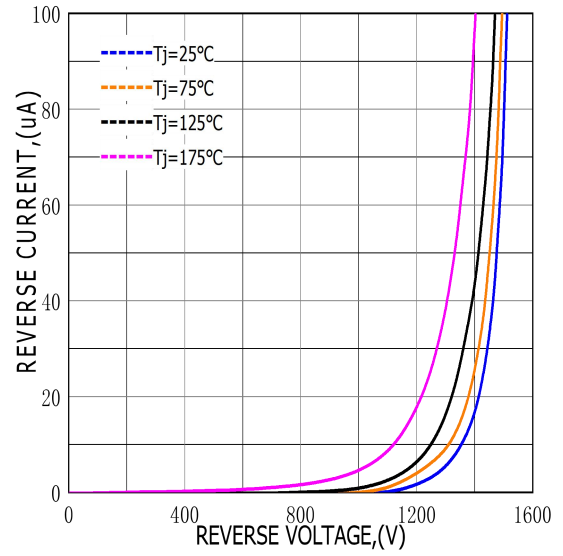

FIG.3-TOTAL CAPACITANCE CHARGE VS REVERSE VOLTAGE

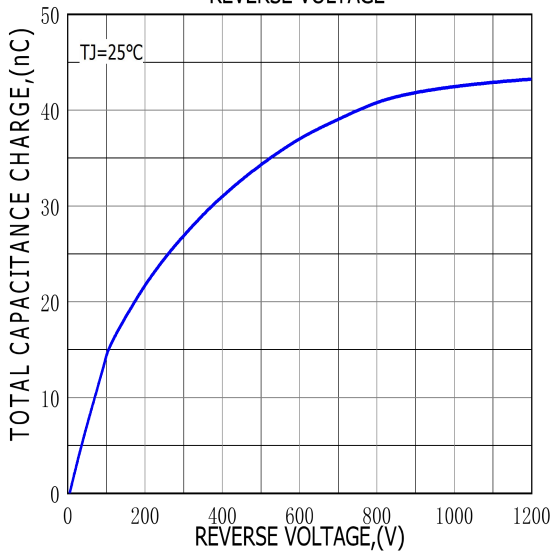
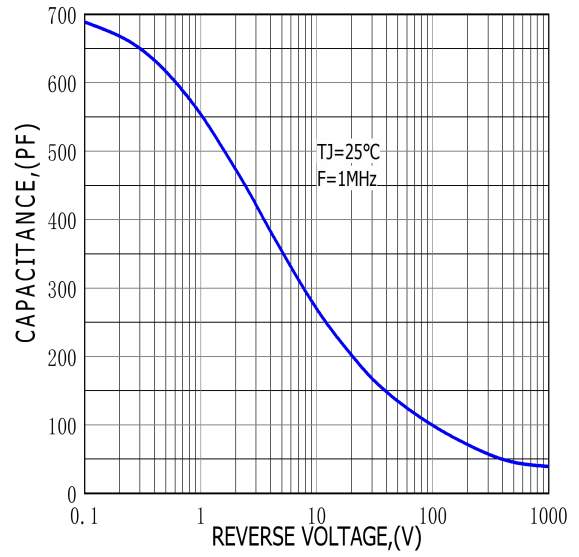
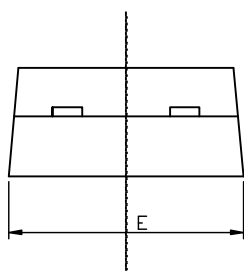
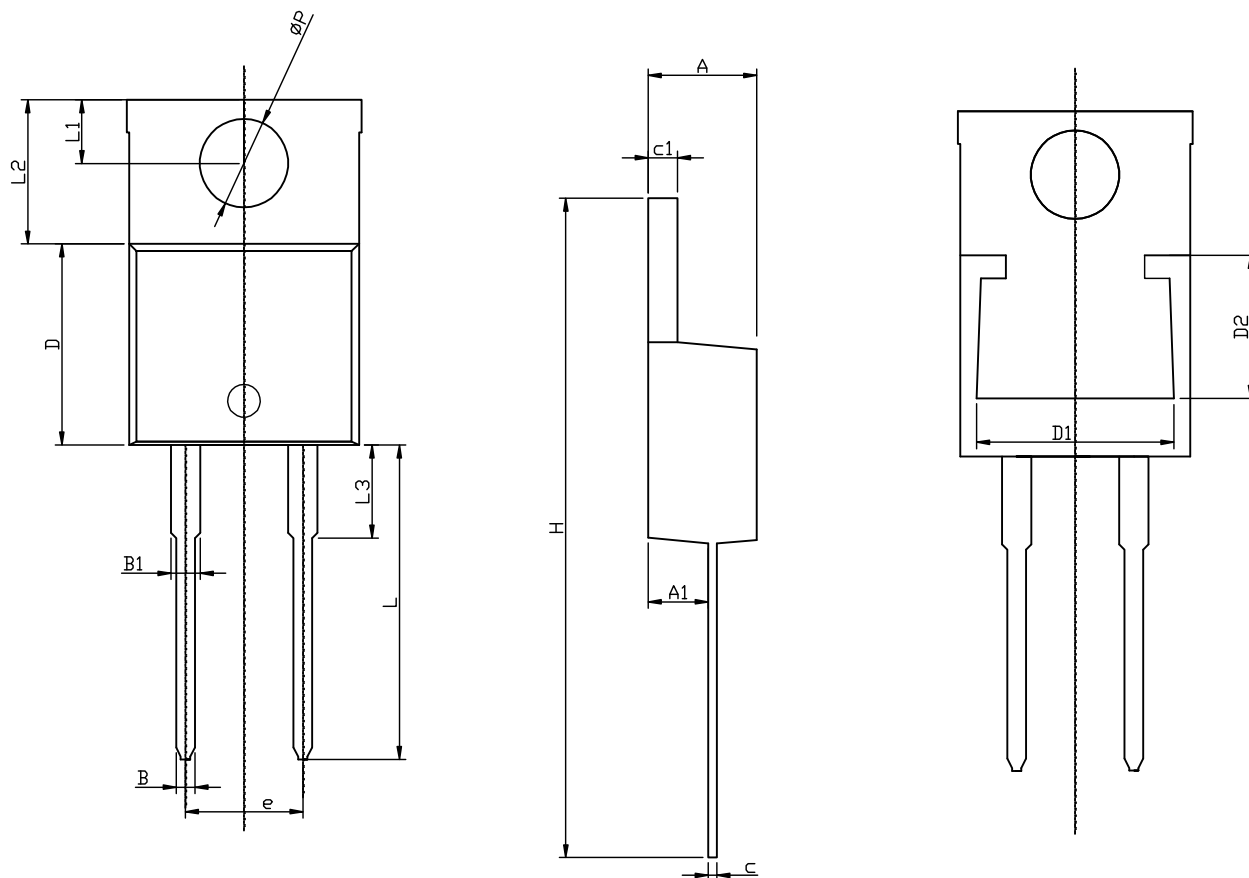

FIG.4-CAPACITANCE VS REVERSE VOLTAGE



## TO-220AD-2L PACKAGE OUTLINE



RECOMMENDED LAND PATTERN

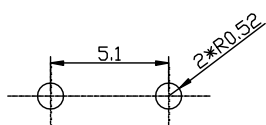

UNIT: mm

	MIN	NOM	MAX
A	4.50	4.70	4.90
A1	2.45	2.60	2.70
B	0.72	0.82	0.92
B1	1.12	1.27	1.42
c	0.28	0.38	0.48
c1	1.17	1.27	1.37
D	8.46	8.66	8.86
D1	7.70	7.90	8.40
D2	5.00	5.20	5.40
e		5.10	
E	9.85	10.15	10.45
H	28.00	28.50	29.00
$\phi P$		3.84	
L	13.1	13.6	14.1
L1	2.54	2.74	2.94
L2	6.04	6.24	6.44
L3	3.85	4.05	4.35